

# HOTEL SUPPLIES

YirouFang Textile Manufacture Co.,Ltd.



Visit Factory

360° VR panoramas we provide



2018-8-15

---

<http://www.yrftextile.com>

Email: [info@yrftextile.com](mailto:info@yrftextile.com)

## Light Filter&Blackout Honeycomb Blinds

Softly Filtering Light and Providing Privacy When Lowered

© ERMAR QUALITY, OFFICE SPACE, SPRINGDALE, COFFIN ROOMS AND BARRIS IN HUNTER





## STUDYROOM

Blocking Stronger Light  
Effective Heat Insulation

Block out light, heat & noise  
Move the control cord to the side

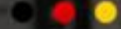

## RESTROOM

Noise Reduction  
Temperature Control

Block out light, heat & noise  
Move the control cord to the side







## KITCHEN

Soft, wrinkle-resistant fabric  
unique honeycomb offers year-round  
style and insulation against heat and cold

Discover the design, it's a great "look" for the kitchen and living room.

ALUMINUM BLINDS

## Needed Nonwoven Fabric

Heat transfer printing and dyeing technology  
Environmental protection and innocuity



# Ball Chain Honeycomb Blinds

## Heat Insulation and Noise Reduction

The only blind for the advantage of green, clean, noise-reducing, sunshade, insulating, fire-retardant, easy opening, and long life span. The only blind to suit for use in the residential and public building.

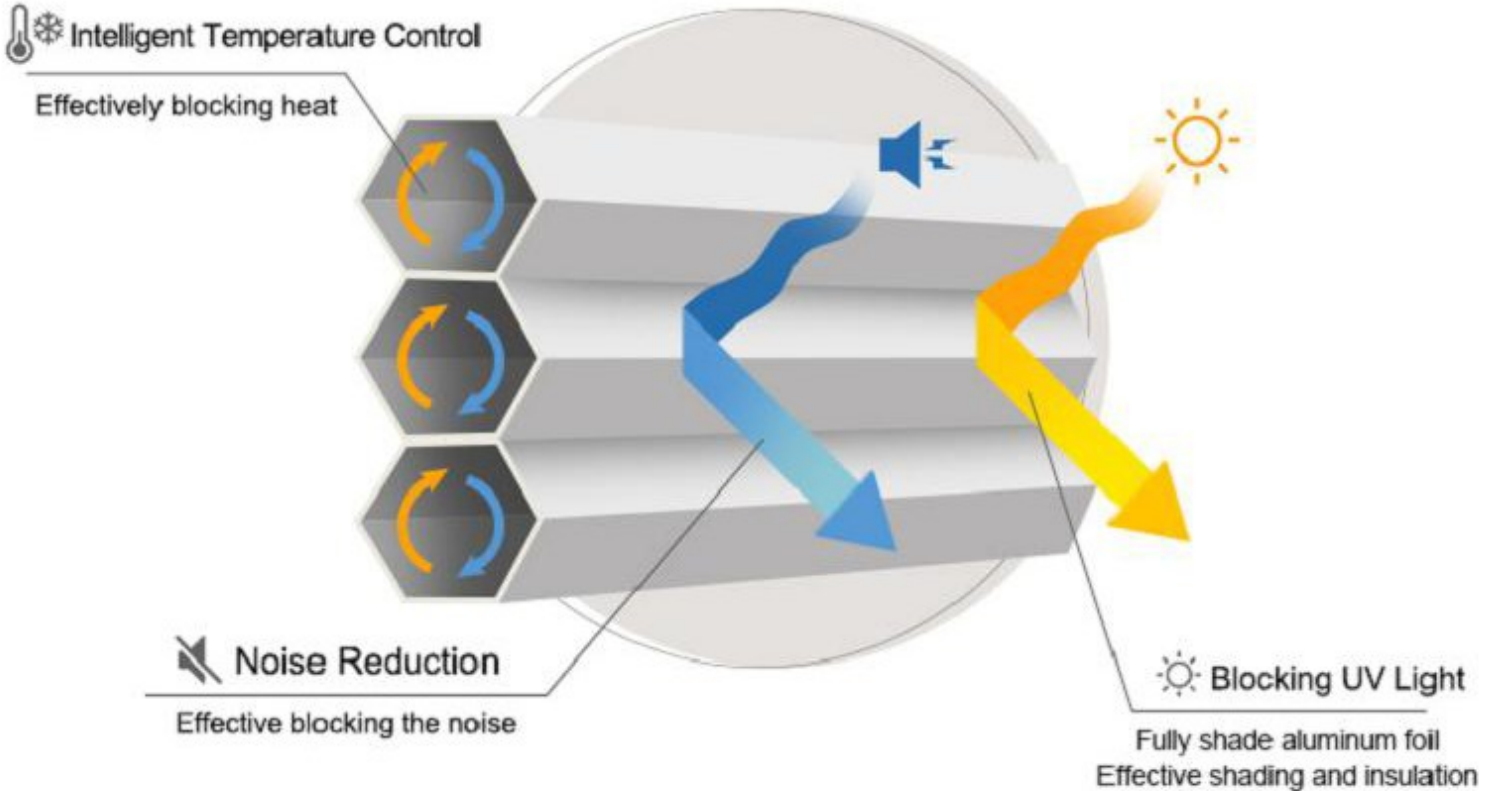

# Daylight/Blackout Two Options

Blackout fabric inside is aluminum foil  
More effective shading

*The unique construction has the advantages of green, efficient, energy saving, and environmental protection. According to the glass area, the shading effect is more effective than ordinary shading.*

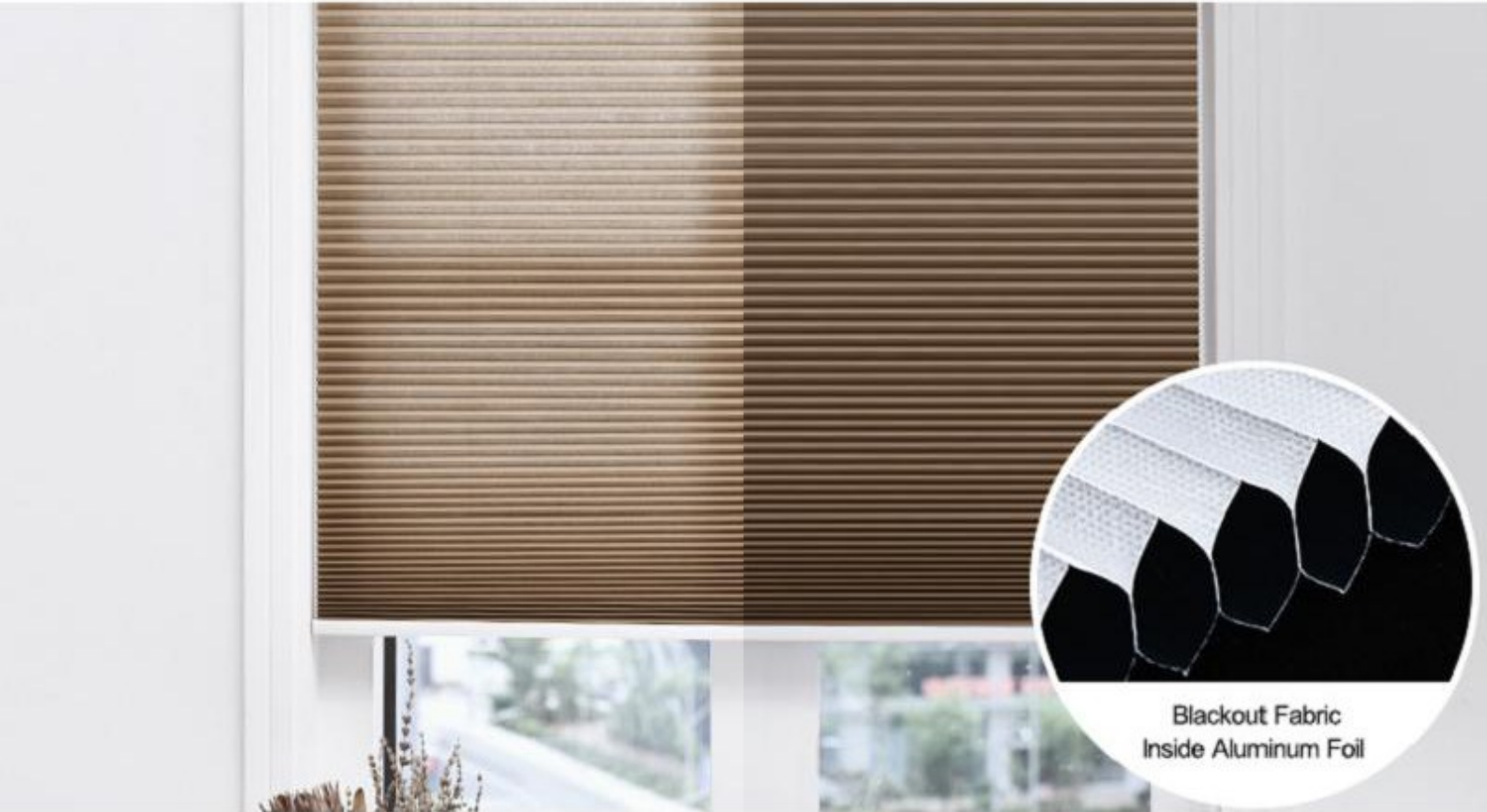

■ Daylight ■

■ Blackout ■

## More Details Highlight Quality

The only window blinds that combine the advantages of wood, aluminum, and vinyl. The result is a great way to protect your privacy and energy efficiency. The only blind that is made from the combination of quality treated wood, aluminum, and vinyl.



Baking Finish Aluminum Rail ▶







◀ Exquisite Handle

Elegant Design

Increase Bead Drape

High Density Plastic Steel Rails ▶

Keep blinds naturally drooping  
Best fit your windows





# Multicolor Optional

The table with the advantages of power driven movement components is resulting the great way processing on any machine on the table multi-axis to avoid the multi-axis of power tool and other methods.



White



Grey



Beige



Camel



Coffee



Oliven Green



Wine Red

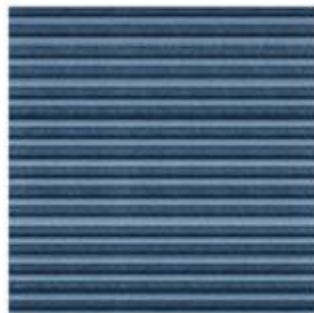

Blue



Yellow

## - Product & Accessories Display -

PRODUCTS AND ACCESSORIES DISPLAY



# Measure and Installation Methods

MEASUREMENT INSTALLATION METHOD



01. Confirm your installation ways before measure

---

Please contact us and tell your installation ways



^ Outside Mount



^ Inside Mount





Inside Open

Outside Mount Only



Outside Open

Outside Mount or Inside Mount



Side Open

Outside Mount or Inside Mount

## 02. Measure Ways

---

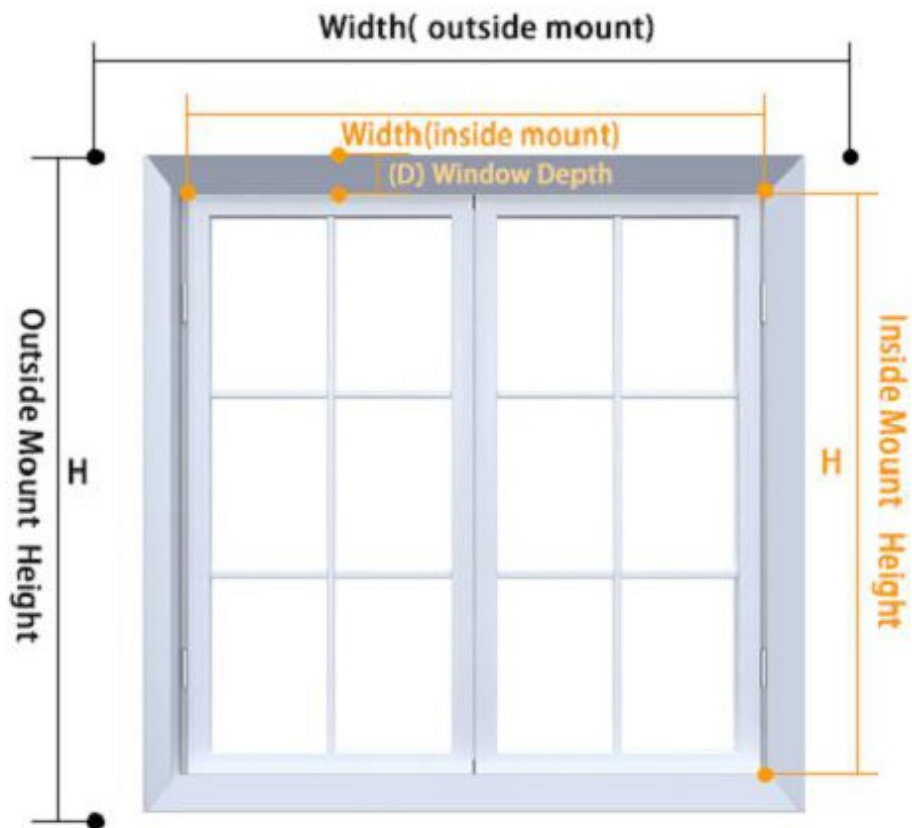

**Tips:** window depth (D) at least 6cm

### Customized Size:

Width Range 50~200cm

Max Height 300cm

### Outside Mount:

Roller blinds width=window width+20cm

Roller Blinds height=window height+20cm

### Inside Mount:

Roller blinds width=window width-1cm

Roller Blinds height=window height

### 03. Installation Ways

---



01. Measure the distance and make on the wall



02. Drill on the wall, make sure two holes are in same level



03. Input the plastic screw into the holes



04. Fix the mounting hardware into the wall

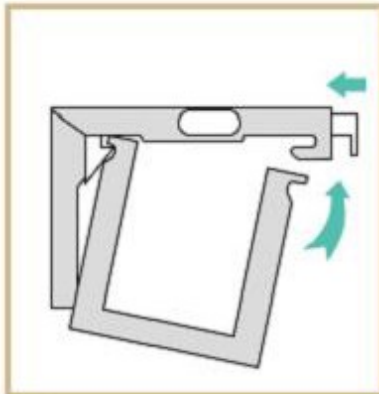

05. Fixed one end of the slot

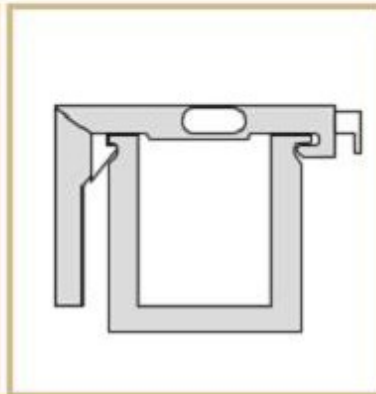

06. Press the white plastic part and then pull up the upper rail



07. Successful installation



**YRF**  
YRFTEXTILE.COM



**Biege/Blackout**

**Backside White**

**YRF**  
YRFTEXTILE.COM



**Blue/Blackout**

Backside White

**YRF**  
YRFTEXTILE.COM



**Camel/Blackout**

**Backside White**



**YRF**  
YRFTEXTILE.COM

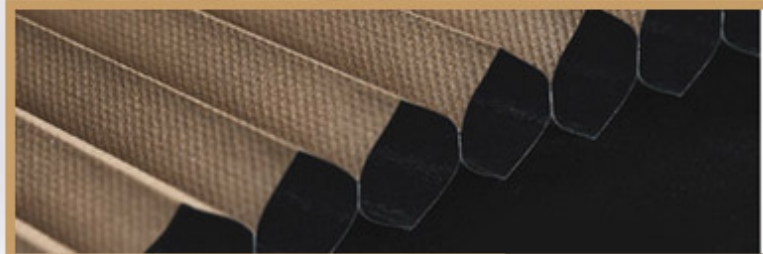

**Coffee/Blackout**

**Backside White**

**YRF**  
YRFTEXTILE.COM



**Grass green/Blackout**

**Backside White**



**YRF**  
YRFTEXTILE.COM

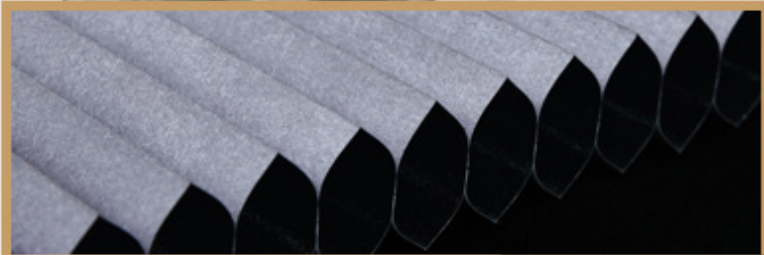
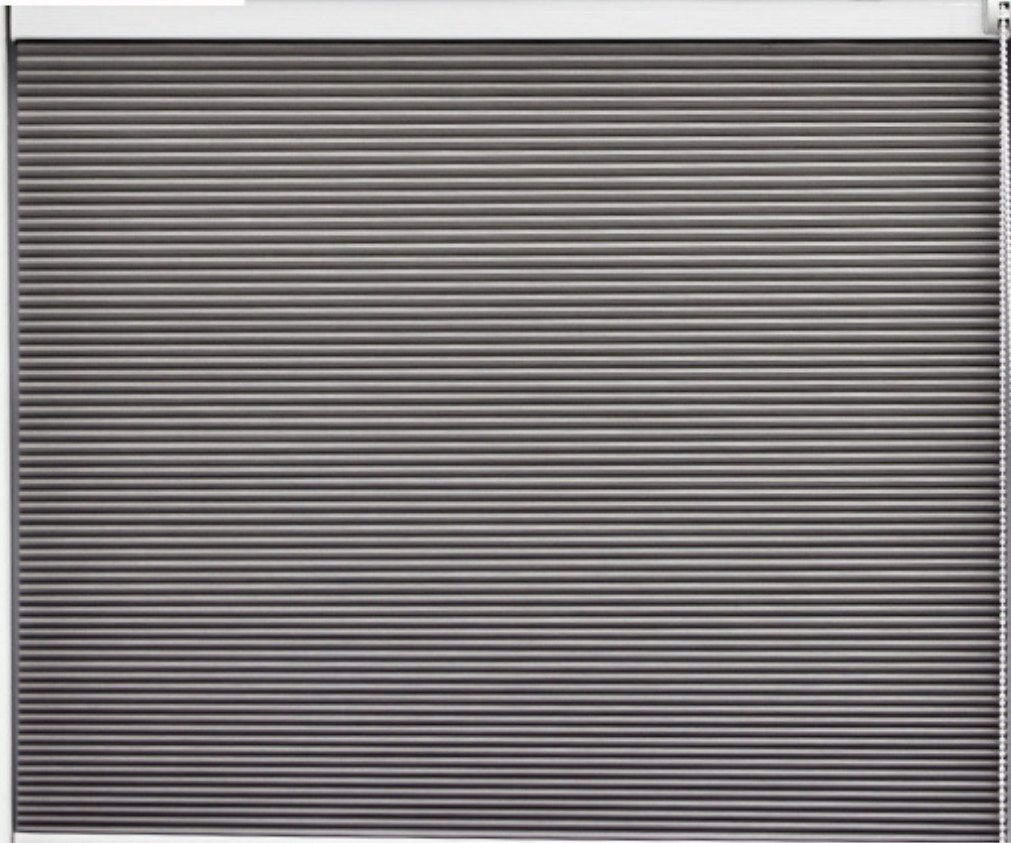

**Grey/Blackout**

**Backside White**



**YRF**  
YRFTEXTILE.COM

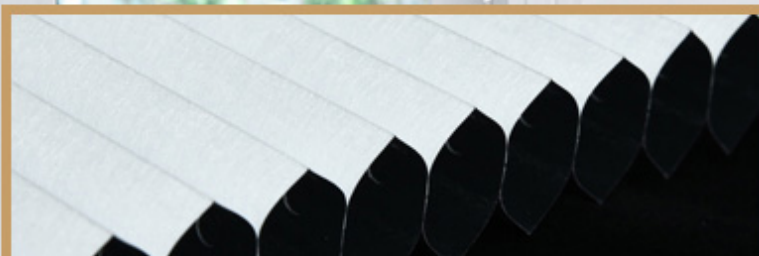

**White/Blackout**

Backside White

**YRF**  
YRFTEXTILE.COM

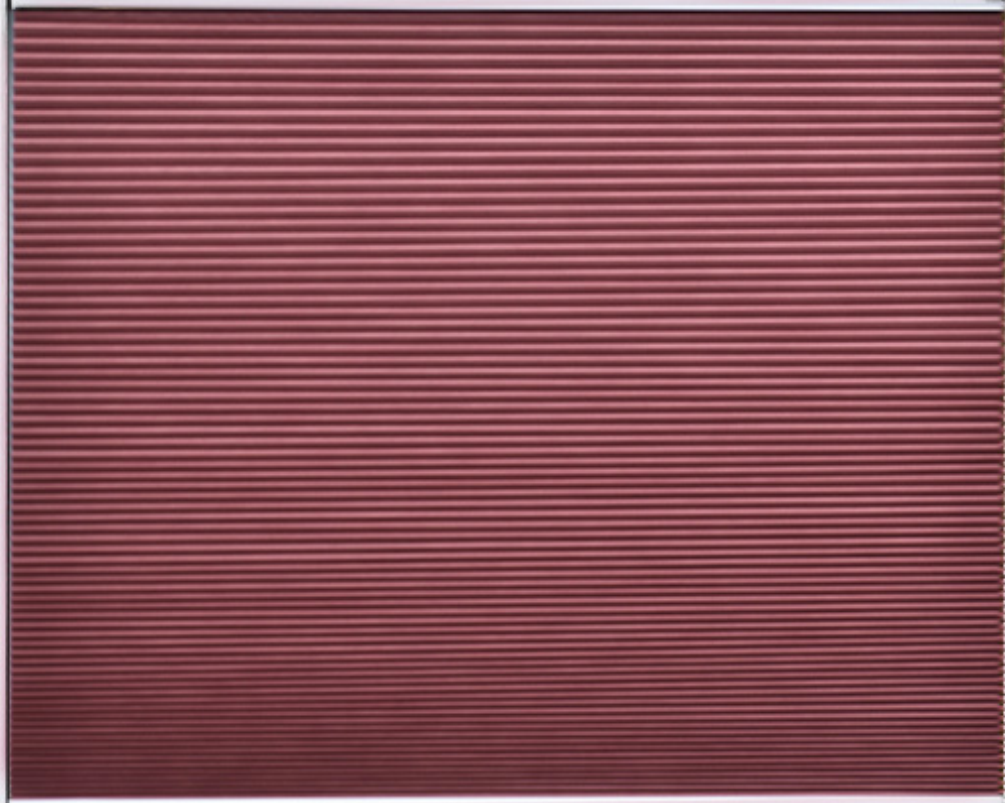

**Wine Red/Blackout**

**Backside White**

**YRF**  
YRFTEXTILE.COM

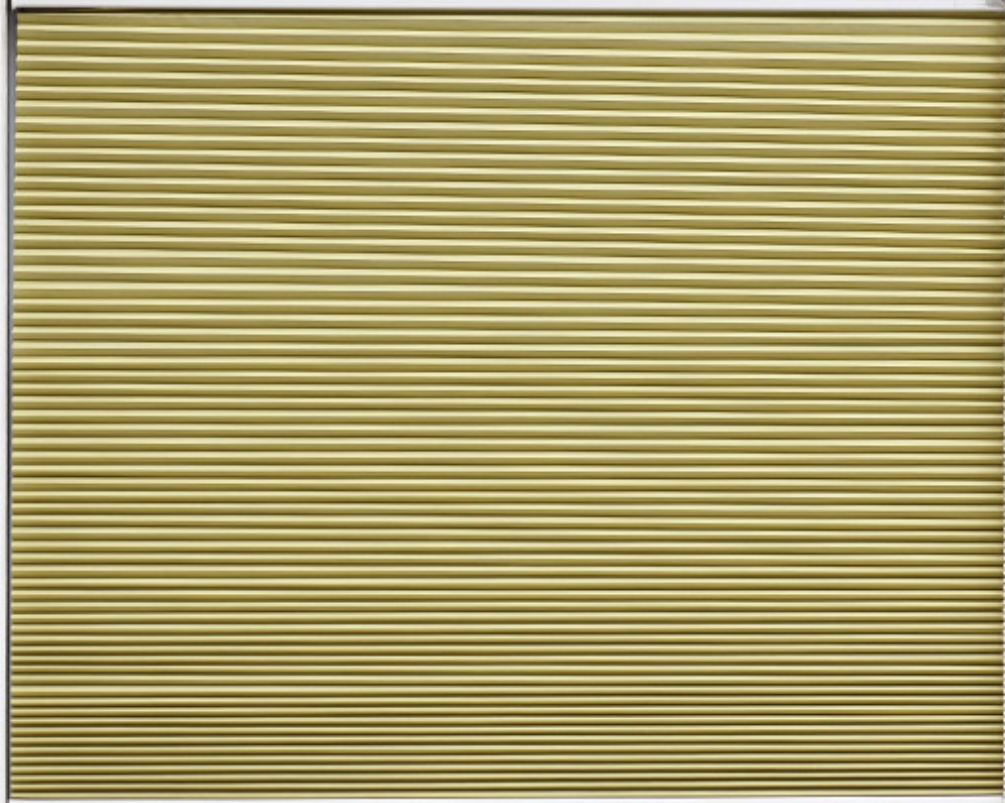

**Yellow/Blackout**

**Backside White**



**YRF**  
YRFTEXTILE.COM

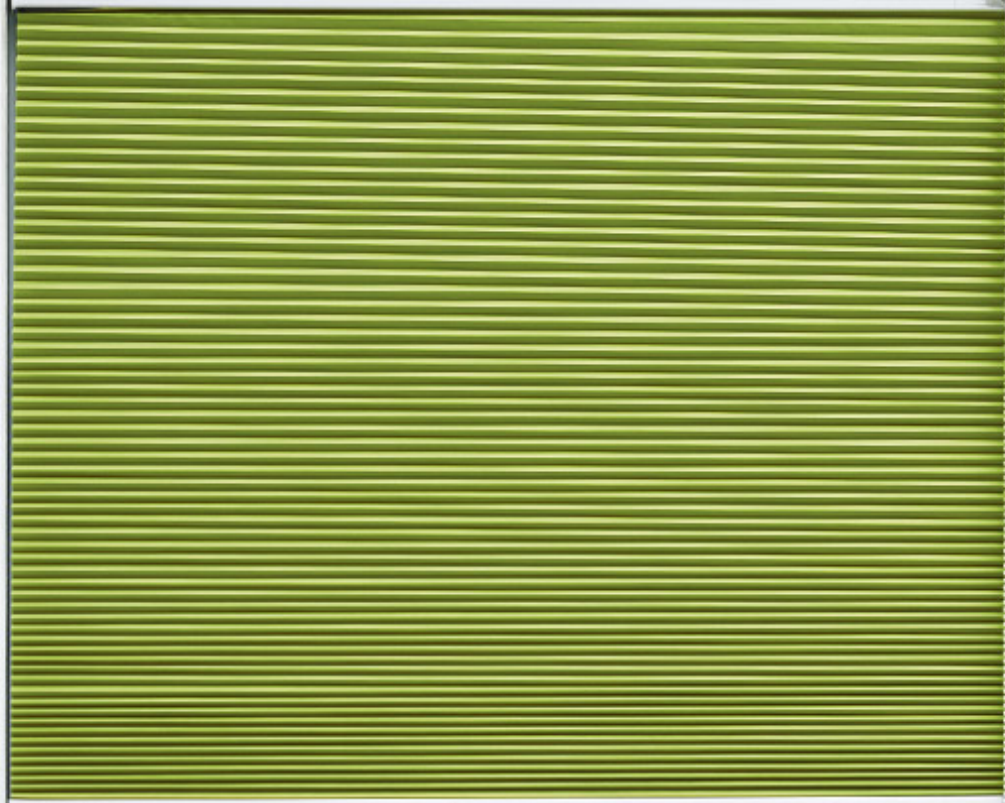

**Oliven green/Blackout**    **Backside White**



**YRF**  
YRFTEXTILE.COM



**Beige/Daylight**

**Backside White**

**YRF**  
YRFTEXTILE.COM

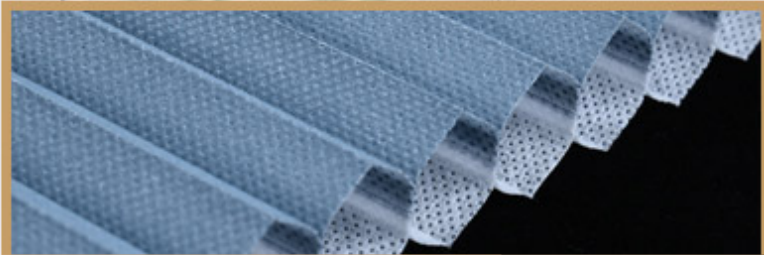
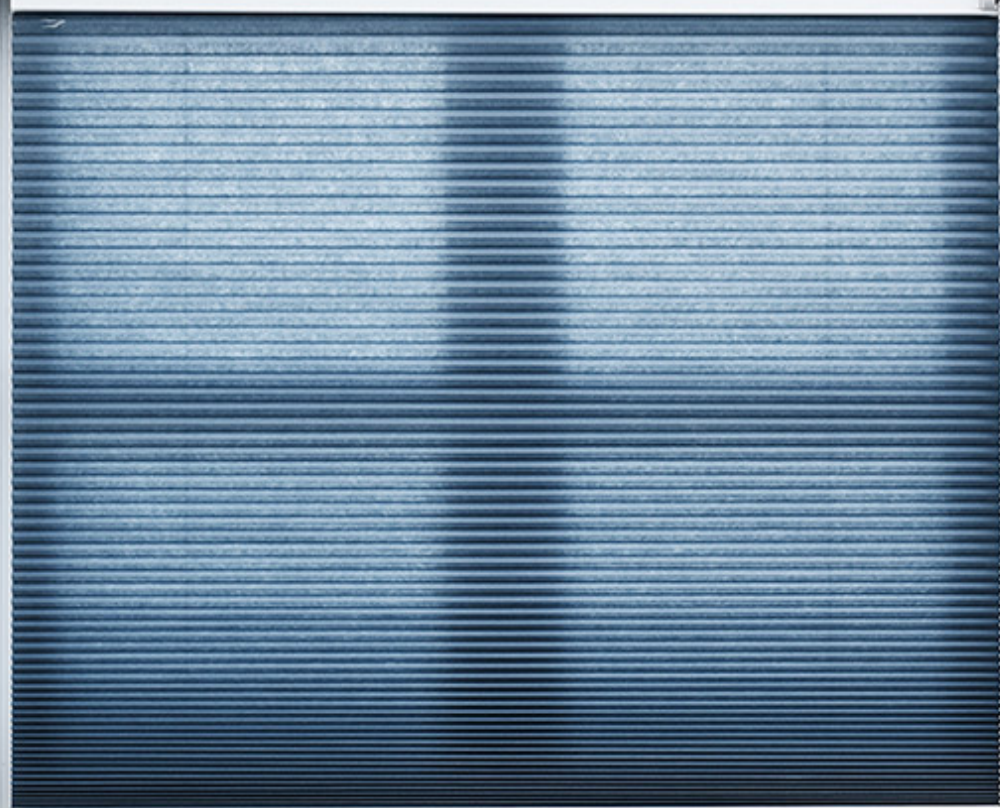

**Blue/Daylight**

**Backside White**



**YRF**  
YRFTEXTILE.COM



**Camel/Daylight**

**Backside White**

**YRF**  
YRFTEXTILE.COM



**Coffee/Daylight**

**Backside White**



**YRF**  
YRFTEXTILE.COM

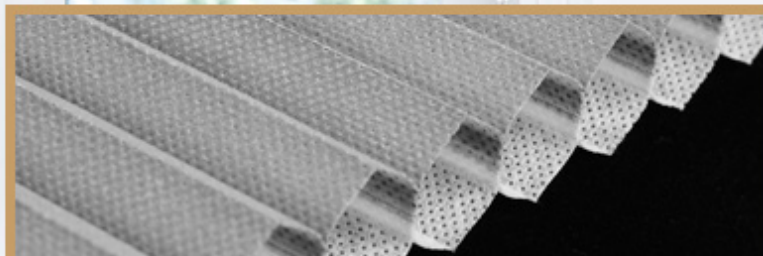

**Grey/Daylight**

**Backside White**

**YRF**  
YRFTEXTILE.COM



**Light Blue/Daylight**

**Backside White**

**YRF**  
YRFTEXTILE.COM

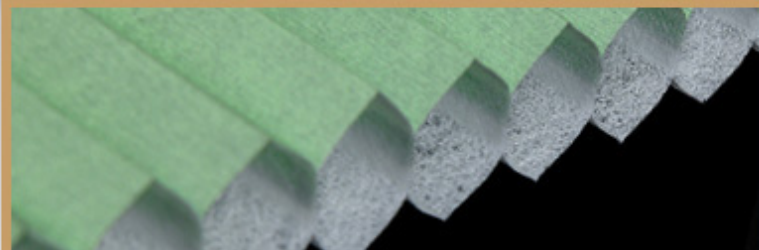
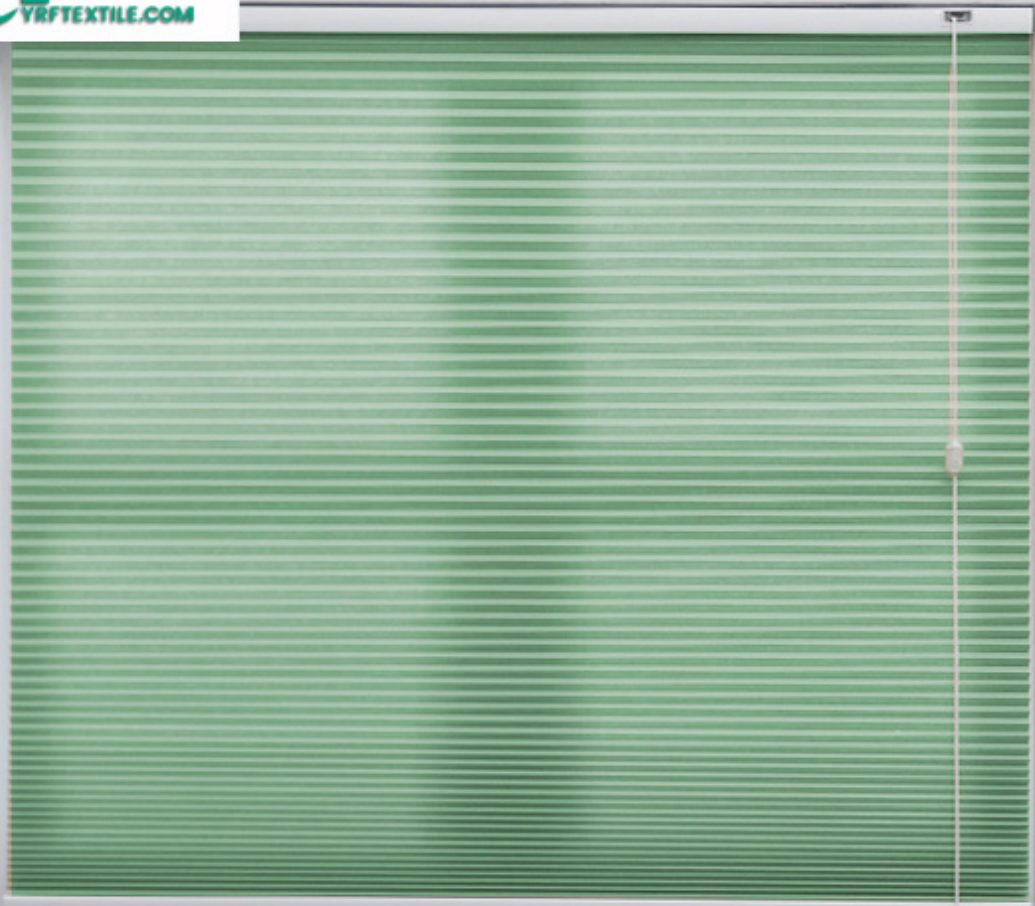

**Green/Daylight**

**Backside White**





**YRF**  
YRFTEXTILE.COM



**Wine Red/Daylight**

**Backside White**



**YRF**  
YRFTEXTILE.COM



**White/Daylight**

**Backside White**

**YRF**  
YRFTEXTILE.COM



**Oliven green/Blackout** Backside White